

Tapered Roller Bearing

d 760,000-838,200mm 29,9183-33,0000 in-

参数信息:

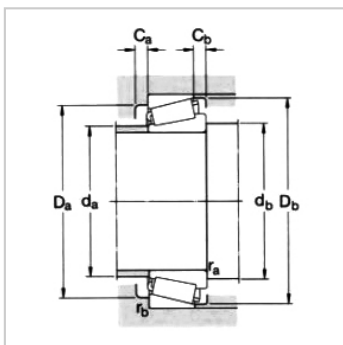
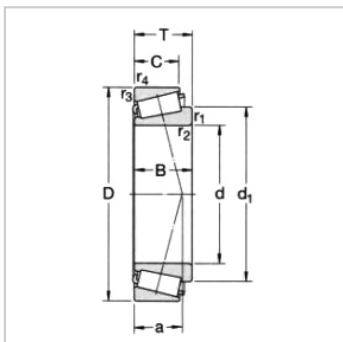

Principal dimensions (mm) :

d :	30
D :	35
T :	3.5

Basic load ratingsKN :

dycCr :	
stcCor :	
Pu :	

Speed ratingsrpm :

Speed Ratings :	
Limiting Speed :	
Weight :	
Designation :	
Series :	

Dimensions mm :

d :	30
d ~ :	
B :	3.5
C :	2.8346
r Min :	0.13
r Min :	0.13
a :	

Abutment and fillet dimensions mm :

d Max :	
d Min :	
Da Min :	
Da Max :	
Db Min :	



Ca Min :

Cb Min :

r Max :

r Max :

Calculation Factors :

e :

Y :

Yo :

: